

Accessories  
Handle lock  
Cylinder lock  
Electronic lock  
Plane lock  
Rod control lock  
Panel lock  
Toggle and hook  
Handles  
Door stop  
Hinge  
Seal gasket

**TX80-1**



**TX80-2**



**Main material and finish:** Bright chrome plated steel body

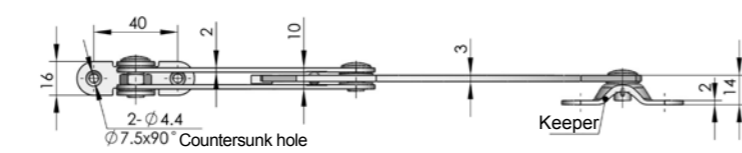
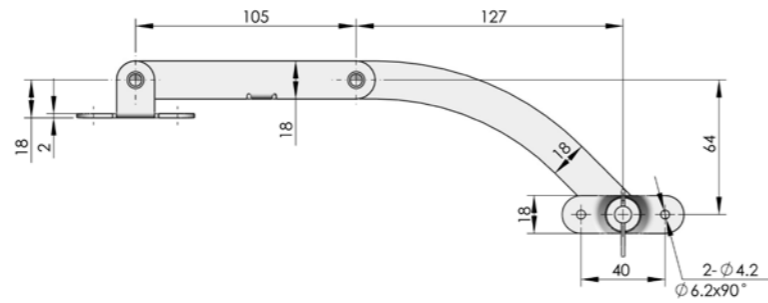

TX80-1

Remarks: change the fitting direction of the keeper to suit RH or LH application

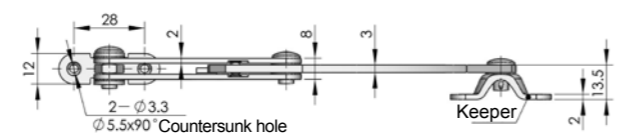
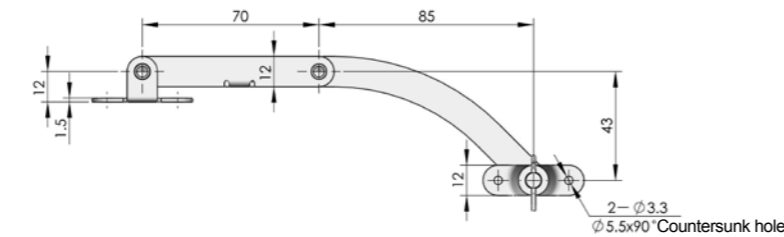

TX80-2

Remarks: change the fitting direction of the keeper to suit RH or LH application

**Example of application**

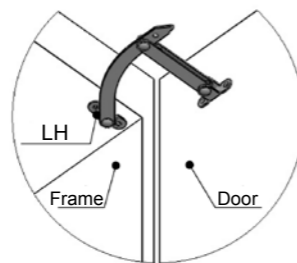

Specification	ERP	
	LH	RH
Steel(Bright chrome plated)	TX080F3A001	TX080F3A002

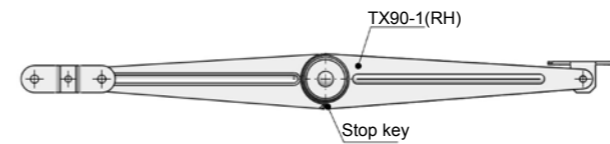
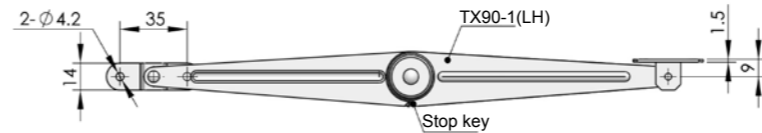
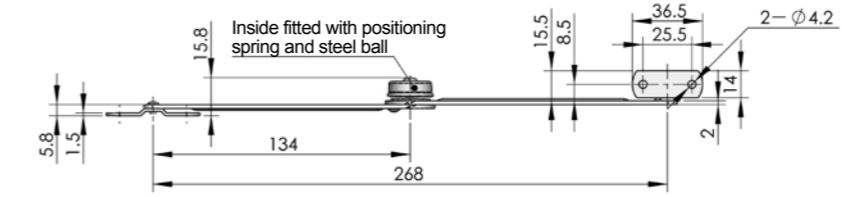

**Example of application**

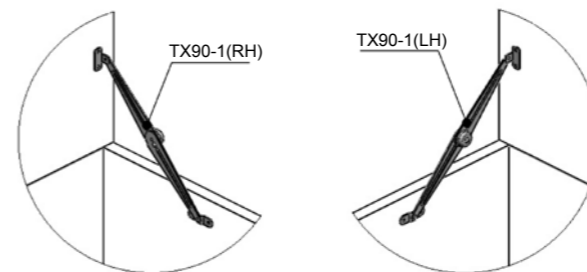

ERP	LH	RH
		TX090F3A001

**TX90-1**



**Main material and finish:** Bright chrome plated steel

Accessories  
Handle lock  
Cylinder lock  
Electronic lock  
Plane lock  
Rod control lock  
Panel lock  
Toggle and hook  
Handles  
Door stop  
Hinge  
Seal gasket