

MS816-3S-1



MS816-3S-2



Main material and finish: Black painted ZDC housing, insert and handle, white zinc-plated steel cam, PA water-proof cap
Application: Cam Quarter-turn to open or close, with function of locking

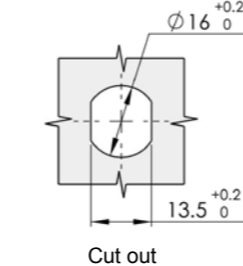
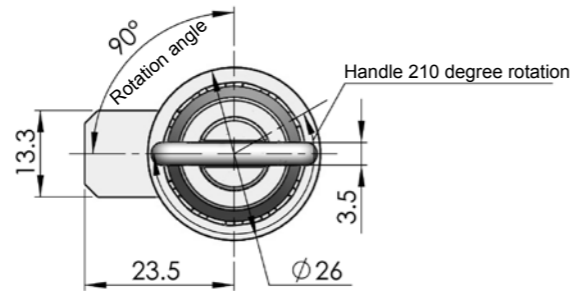
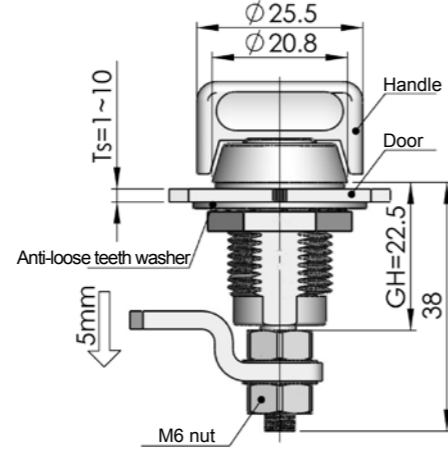

WP004(Optional)

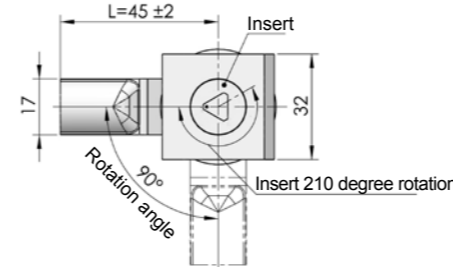
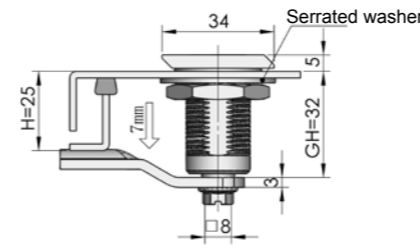

Unadjustable type

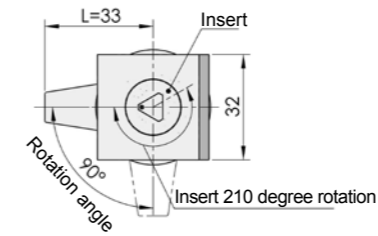
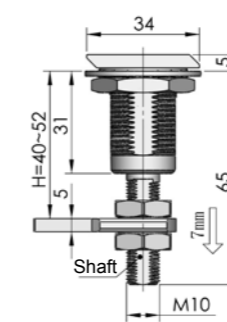
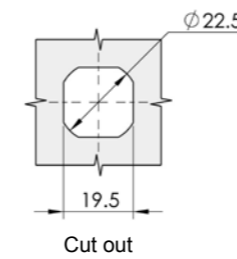

Adjustable type

MS817



Main material and finish: Black powder coated ZDC housing and insert, white zinc plated steel cam
Application: Cam Quarter-turn to open or close, with function of locking
Remarks: Optional key K15

Default cam : S1K45N07016(Unadjustable)
 S1M33Y00002(Adjustable Ts=4)

Cam(Optional)

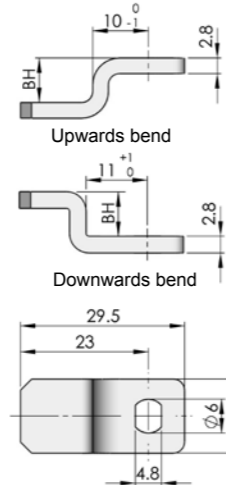

Remarks: Please refer to cam list on P009

Specification	ERP	Optional key
Handle	MS816Z2A000001	
6mm Square	MS816Z2AT05001	K15-05A
Abnormal	MS816Z2AT21001	K370
Slot	MS816Z2AT18001	

Remarks: ERP excludes cam (Cutout $\varnothing 6 \times 4.7$)

key(Optional)

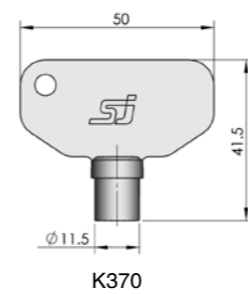
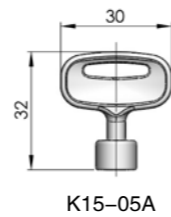

Remark: Inserts sketch refers to insert list 2 on P060

Specification	ERP		Optional key
	Non-adjustable	Adjustable	
8mm Triangle	MS817Z1AT04001	MS817Z1AT04002	K15-03A, K15-03F
S Hook	MS817Z1AT03001	MS817Z1AT03002	K15-01A
8mm Socket hexagon	MS817Z1AT24001	MS817Z1AT24002	
10mm Hexagon	MS817Z1AT25001	MS817Z1AT25002	K15-09A, K15-09F
8mm Square	MS817Z1AT07001	MS817Z1AT07002	K15-04B, K15-04F
7mm Square	MS817Z1AT06001	MS817Z1AT06002	K15-06A, K15-06F
9mm Square	MS817Z1AT26001	MS817Z1AT26002	
Slot	MS817Z1AT10001	MS817Z1AT10002	
7mm Triangle	MS817Z1AT14001	MS817Z1AT14002	K15-03A, K15-03F
Abnormal	MS817Z1AT21001	MS817Z1AT21002	K310

Remarks : ERP excludes Cam